

Installation & Maintenance Manual

Economy Manifold



Contents

User Responsibility	3
Introduction	4
Features	4
Description of the Manifold	5
Shipment Details	5
Description of Parts	5-6
Pressure Regulators (Operating & Line)	5
Pressure Relief Valves	5
Pressure Relief Valve Chart	5
Control Components	6
Warning System Components	6
Operating Alarm Systems	6
Safety Features	6
Installation	7
Receipt and Location	7
Cylinder Bank Installation Instructions	7
Operation Procedures	8
Maintenance	9
General Maintenance	9
Control Equipment	9
Cylinder Extension Bars	9
Periodic Standing Pressure Test	9
Troubleshooting	10
Cylinder Changing Procedures	11
Ordering Information	12
Parts list	12
Appendix A: Manifold Internal Layout	13
Appendix B: Manifold Dimensions	14
Appendix C: Wiring to Alarm/Buzzer	15

User Responsibility

The information contained in this Installation and Maintenance Manual pertains only to the Amico Economy Manifold. This product will perform in conformity with the descriptions contained in this manual when assembled, operated, maintained and serviced in accordance with the installation instructions provided.

The manifold **MUST** be checked periodically. Parts that are broken, missing, worn, distorted or contaminated must be replaced immediately. Should such repair or replacement become necessary, please contact Amico Corporation or their distributors.

All Manifolds should not be repaired or altered without prior written approval by Amico Corporation or its distributors. Failure to comply will void all warranty on the manifold.

Statements in this manual preceded by the words **WARNING**, **CAUTION**, **DANGER** and **NOTE** are of special significance. Please read these sections carefully.



WARNING: denotes steps which can prevent injury.



CAUTION: denotes steps which can prevent damage to equipment.



DANGER: denotes steps which can prevent electrical shock to equipment or prevent serious injury and/or death.

Introduction

The Amico Economy Manifold incorporates the basic necessities for the distribution and monitoring of medical gases. The manifold has been designed to provide user flexibility and reliability. This manual will enable the customer to install, use and maintain the manifold properly.

The total amount of medical gas contained in the left and right banks is displayed on the analog gauges on either side of the manifold. These gauges are provided to show the cylinder bank pressure "In Use" and the cylinder bank pressure "In Reserve" at all times.

When the gas cylinder pressure depletes on the "In Use" (primary) side, below the set point of the pressure switch, a signal will go to the master alarm (or remote buzzer) informing the facility personnel that the "In Use" cylinder bank pressure is low and the cylinders need replacement. At this point, it is necessary to silence the alarm (or buzzer) and manually switch the lever from the depleted bank to the full bank to indicate the bank "In Use." The next step is to change the cylinders. Open the new cylinders to automatically reset the pressure switch and cancel the alarm condition.

NOTE: BEFORE changing the empty cylinders, move the lever over from the depleted "In Use" bank to the "Reserve" bank to indicate the bank supplying pressure.

FEATURES INCLUDE:

- Heavy duty line regulator to produce optimum gas flow
- Pressure switch with dry contacts to indicate Reserve In Use alarm
- Check valves provided to prevent back flow from one bank to another
- Removable cabinet enclosure for easy installation and service
- Maximum inlet pressure is 3,000 psi (20,685 kPa)
- Maximum delivery pressure is 180 psi (1,242 kPa)

Description of the Manifold

SHIPMENT DETAILS

The package consists of one fully tested Economy Manifold. Optional header bar assemblies and pigtails are available.

DESCRIPTION OF PARTS

The Economy manifold is divided into two main sections:

Pressure Regulators

There are two types of regulators in the Amico Corporation manifold: the operating pressure regulator and the line pressure regulator. Both types conform to NFPA 99.

- i. Operating (bank) Regulators: There are two operating regulators on every manifold, one for the left bank and one for the right bank. For Oxygen, Nitrous Oxide, Medical Air and Carbon Dioxide service, the “In Use” regulator will be set at 160 psi and the “Reserve” regulator will be set at 120 psi. For Nitrogen, the “In Use” regulator will be set at 250 psi and the “Reserve” regulator will be set at 200 psi.
- ii. Line Regulator: There is one heavy duty line regulator on every manifold. The line regulator is capable of maintaining a constant dynamic delivery pressure at the maximum design flow rate of the system. For Oxygen, Nitrous Oxide, Medical Air and Carbon Dioxide service, the line regulator should be set at 55 psig (379 kPa). For Nitrogen service, the regulator is set at 170 psig (1,172 kPa).

Pressure Relief Valves

Pressure relief valves are installed downstream of all pressure regulators and are set at no more than 50% above the setting of the pressure regulator located immediately upstream. All pressure relief valves are capable of fully relieving the pressure at the set point.

Pressure relief valves in the manifold have piping connections to allow for connection of vent lines to outside facilities.

Relief pressure settings vary with gas service as follows:

	Oxygen	Carbon Dioxide	Nitrous Oxide	Medical Air	Nitrogen
Line Pressure Relief Valve	75 psi (517 kPa)	75 psi (517 kPa)	75 psi (517 kPa)	75 psi (517 kPa)	225 psi (1,551 kPa)
Operating Pressure Relief Valve	350 psi (2,413kPa)	350 psi (2,413 kPa)	350 psi (2,413 kPa)	350 psi (2,413 kPa)	350 psi (2,413 kPa)

CONTROL COMPONENTS

The Economy manifold qualifies as a “Cylinder System without Reserve Supply” as classified in NFPA 99, Clause 4-3.1.5. This is a category of the broader classification “Central Supply System” which encompasses many types of sources of supply to nonflammable medical gas piping systems.

Description of the Manifold

WARNING SYSTEM COMPONENTS

The Economy Manifolds have the capability to be connected to external devices whose function is to give continuous information as to the state of operation of the system (i.e. an alarm condition).

Operating Alarm Systems

Operating alarm systems are mandatory according to CSA/Z305.1. Amico Corporation supplies a complete range of operating alarm units which can be used in conjunction with the manifold in order to provide the required visual and audible signal in suitable locations, when changeover from the primary supply to the secondary supply occurs and cylinder replacement is necessary.

Mounted with the manifold is a preset pressure switch. Its function is to send a signal to the alarm unit when the operating pressure drops below its set point. For Medical Air, Oxygen, Carbon Dioxide, and Nitrous Oxide the pressure switch will be set at 140 psi. For Nitrogen the pressure switch will be set at 225 psi.

Safety Features

GAS SERVICE IDENTIFICATION

Amico Corporation manifolds are clearly labelled for the gas that they are intended to be used for. A nameplate, indicating the appropriate gas, is attached on the front of the manifold cabinet. There is one pipe extending from the top of the manifold. Two pressure relief valves within the cabinet come with pipe away adaptors that could be easily connected to the vent out pipe.

CYLINDER CONNECTIONS

All cylinder extension bar connections, as well as pigtail hose assemblies, comply with CGA Standard B96, "Compressed Gas Cylinder Valve Outlet and Inlet Connections."

Installation

RECEIPT AND LOCATION

The Amico Corporation manifold should be carefully examined upon receipt. If any damages are found, a claim should be filed with the Transport Company and Amico Corporation. Any authorized dealers and distributors should also be notified immediately if applicable.

CYLINDER BANK INSTALLATION INSTRUCTIONS:



CAUTION: This section contains important information necessary for proper installation of the cylinder banks. Read it carefully before installing cylinder banks.

Connect the two high pressure inlet valves/header bar assemblies to the CGA connection on each side of the cabinet.

Secure the cylinder extension bar to the support using the U-bolts supplied as part of the assemblies.

Remove the plug and chain assembly on each outlet connection on the cylinder extension bar. Attach the cylinder pigtailed to the header bar connections while ensuring the check valves are operating in the proper direction.

When the medical gas piping system has been tested in accordance with Part 4-5, Testing of NFPA 99, the Amico Economy Manifold can then be connected to it.

The outlet pipes leading from the Amico Economy Manifold should be connected to their respective pipeline system connections. The connection to the relief valves should be made with a union (supplied by others) to facilitate changes if required.

As the threaded joints are installed, an appropriate sealing compound that is suitable for the gas being transmitted shall be used.

Operation Procedure

The following instructions must be followed for all gasses except Nitrogen:

1. Make sure the lever is set to indicate the bank "In Use".
2. The "In Use" regulator is set to 160 psi with the "Reserve" regulator set to 120 psi.
3. When the "In Use" side depletes pressure down to approximately 120 psi, the "Reserve" bank will take over and start to supply gas.
4. The pressure switch is set to 140 psi decreasing pressure and will alarm when the "In Use" bank is depleted.
5. To switchover, simply move the lever from the depleted bank to the opposite bank to indicate the bank "In Use". This resets the pressure switch.
6. Now change the cylinders in the empty bank.
7. The system is now ready for the next switchover.
8. The normal pressure setting for the line regulators is 55 psi.

FOR NITROGEN MANIFOLDS:

The "In Use" regulator is set to 250 psi and the "Reserve" at 200 psi. The pressure switch should be set to 225 psi decreasing pressure while the normal pressure setting for the line regulators shall be 170 psi.

Maintenance

GENERAL MAINTENANCE

The tests and inspections specified below apply only to the Amico Economy Manifold and not to the medical gas pipeline system as a whole. They are intended to help ensure the proper operation of the manifold and not to be interpreted as repair instructions. Fault finding and repair procedures are given in the Troubleshooting section of this manual.

CONTROL EQUIPMENT

Control equipment should be inspected and tested according to the following schedule:

1. PRESSURE REGULATOR

- Observe and record line pressure periodically
- Test for external leaks annually

2. PRESSURE RELIEF VALVES

- Determine the pressure at which relief occurs at least annually and compare with the requirements of clause 4-3.1.8.5. of NFPA 99.

3. HIGH PRESSURE INLET VALVE (MANIFOLD HAND VALVES)

- Inspect once annually and test for external leakage and tightness when opening and closing the valve.

CYLINDER EXTENSION BARS

The following components shall be inspected annually:

1. Test check valves of pigtail assemblies for proper closure.
2. Inspect pigtail assemblies for apparent damage and thread damage to cylinder connections, replacing all damaged pigtails immediately.

NOTE: Replace ALL pigtails after five years of service. The cylinders and the operating regulators of a Nitrous Oxide or a Carbon Dioxide supply system shall be observed daily during peak demand periods to determine whether they show frosting or condensation on the surface. Where this is evident, the system shall be further inspected for evidence of leaks and should excessive condensation or frosting occur, the option would be to add more cylinders to increase the volume or to upgrade to an Amico Corporation Microprocessor Automatic Manifold with a built in heater kit.

PERIODIC STANDING PRESSURE TEST

At intervals of not more than two years, a one hour standing pressure test shall be made on each medical gas system to check for leakage.

Troubleshooting

This section is intended to serve as a general guide for identifying the potential functional problems which occur in operation of the Economy manifold.

When an asterisk (*) appears beside the CORRECTIVE ACTION, the recommended procedure is to replace or rebuild the unit using the repair kit.

Components removed for maintenance must be serviced, repaired and tested only by personnel qualified to work on equipment used in medical service. Only original manufacturer's parts, as supplied by Amico Corporation, may be used in the maintenance of Amico Corporation manifolds.

OPERATING REGULATOR FAULTS

SYMPTOM	CAUSE	CORRECTIVE
Gas leakage around operating pressure regulator body cap	Loose cap	Tighten cap
	Worn out diaphragm	*Replace regulator with substitute unit or use repair kit to rebuild
Venting at intermediate relief valve	Over pressure due to creeping or faulty regulation by pressure regulator	* Replace regulator with substitute unit or use repair kit to rebuild

LINE PRESSURE REGULATOR FAULTS

SYMPTOM	CAUSE	CORRECTIVE
Pipeline not at desired pressure	Line regulator not set correctly	Set line regulator to value specified on page 5 under Line Regulator
Required gas flow not available	Line regulator not set correctly	Set line regulator to value specified on page 5 under Line Regulator
Low pressure relief valve venting	Line regulator set at too high a delivery pressure	<ul style="list-style-type: none"> • Set line regulator to value specified on page 5 under Line Regulator • Check the regulator diaphragm and seat assembly for a rip or other damages * Rebuild or replace assembly as necessary *Replace relief valve if it doesn't reseal
	Line regulator creep	

Cylinder Changing Procedures

1. Keep the main bank valve open throughout these procedures.
2. Close cylinder valves on all empty cylinders.
3. Disconnect pigtails from cylinder valve outlets using an appropriate wrench.
4. Place protective caps over the cylinder valves of the empty cylinders and move them aside.
5. Remove protective caps of the full cylinders. Visually inspect the cylinder valves for dust, grease and oil.
6. Using a clean (lint free) cloth, wipe each cylinder valve outlet clean. Do not use your fingers.
7. Standing to one side, "crack" the cylinder valves by briefly opening and closing them to blow out any dust. Make sure they are pointing away from you and other personnel.
8. Connect the pigtails to the cylinder valve outlets and tighten the nut with an appropriate wrench.
9. Very S-L-O-W-L-Y open the cylinder valve on the cylinder closest to the control cabinet. Watch the bank pressure display on the front of the cabinet to make sure the pressure rises slowly to the full cylinder pressure reading.
10. Wait one full minute.
11. Proceed to S-L-O-W-L-Y open the remaining cylinder valves one at a time.



WARNING: High pressure Oxygen systems must be handled with CAUTION. Spontaneous combustion may result if Oxygen comes in contact with grease or oil. Ensure that hands, gloves, clothing and tools are kept clean and free of oil and grease. Be careful not to introduce dust or other contaminants into the system when changing cylinders. Failure to comply with this procedure may be hazardous.



WARNING: Fire hazard. DO NOT permit smoking or any other source of ignition in the area where the manifold is located or near the relief valve vent outlet. Be certain that all connections are free of dirt, grease and oil. These substances burn with great intensity in air enriched with Oxygen or Nitrous Oxide and some gas mixtures.

Ordering Information

Manifold Cabinet:

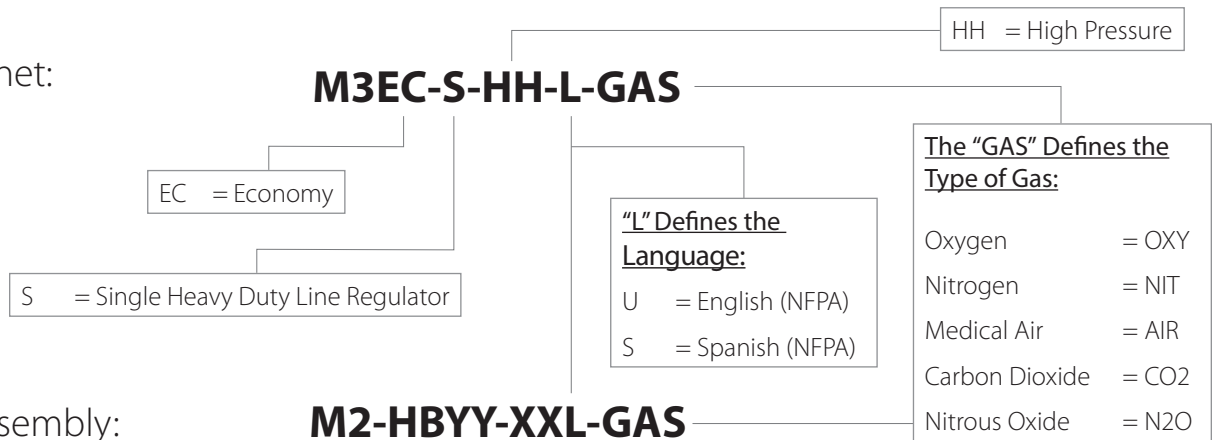

Header-Bar Assembly:

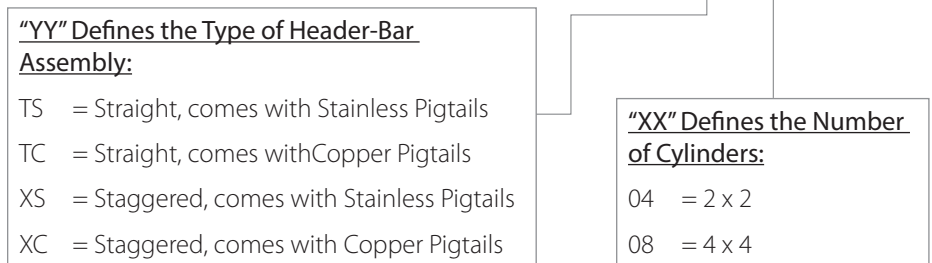

Wall Bracket for Header-Bar Assembly: **M-X-HB-WLBRKIT**

Parts list

DESCRIPTION	MODEL NUMBER
Line pressure regulator for Oxygen, Nitrous Oxide, Medical Air, and Carbon Dioxide	M2-X-MAN-42E-EC
Line pressure regulator for Nitrogen	M2-X-MAN-42E-ECN
Left operating pressure regulator	M3-X-MAN-18-ECL
Right operating pressure regulator	M3-X-MAN-18-ECR
Line regulator repair kit	M2-REG700-RK
Operating regulator repair kit	M2-REG250-RK-HP
Operating check valve for all gases	M-X-MAN-33B
Line pressure relief valve for all gases except Nitrogen	M-X-IN-72W-075
Operating pressure relief valve for all gases	M-X-IN-72W-225
Line pressure relief valve for Nitrogen	M-X-IN-72W-350
Operating Pressure relief valve for Nitrogen	M-X-IN-72W-350
Copper pigtail, comes with check valve for Oxygen, Nitrous Oxide, Carbon Dioxide and Nitrogen	M-X-HB-PTC-GAS (OXY, N2O, AIR, CO2 & NIT)
Stainless steel pigtail, comes with check valve for Nitrous Oxide, Carbon Dioxide and Nitrogen	M-X-HB-PTS-GAS (N2O, AIR, CO2 & NIT)
High pressure inlet header bar valve	M-X-HB-HPVLV-A
Pressure switch	M-PRSW-NIT

Appendix A

Manifold Internal Layout

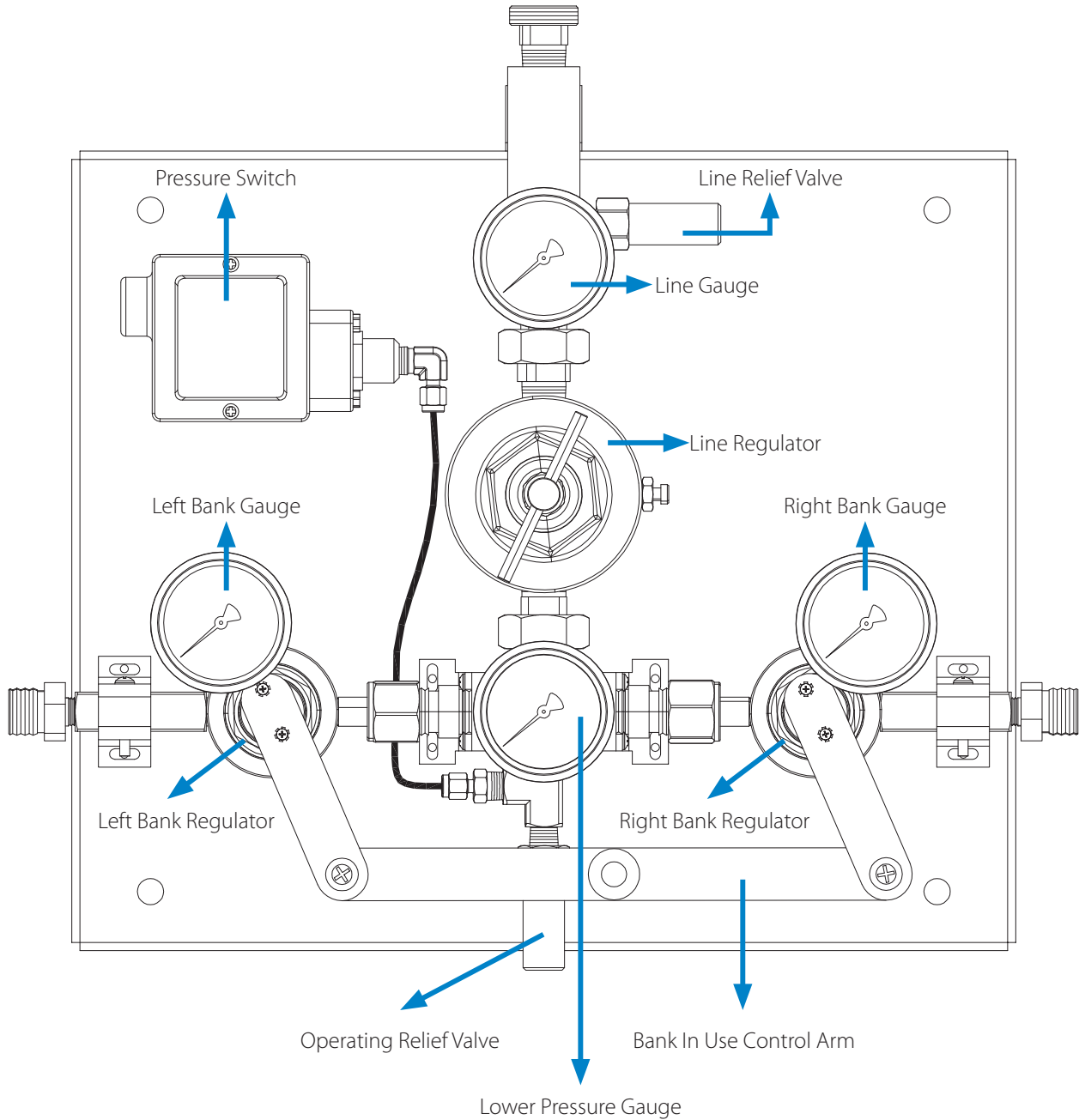

Appendix B

Manifold Dimensions

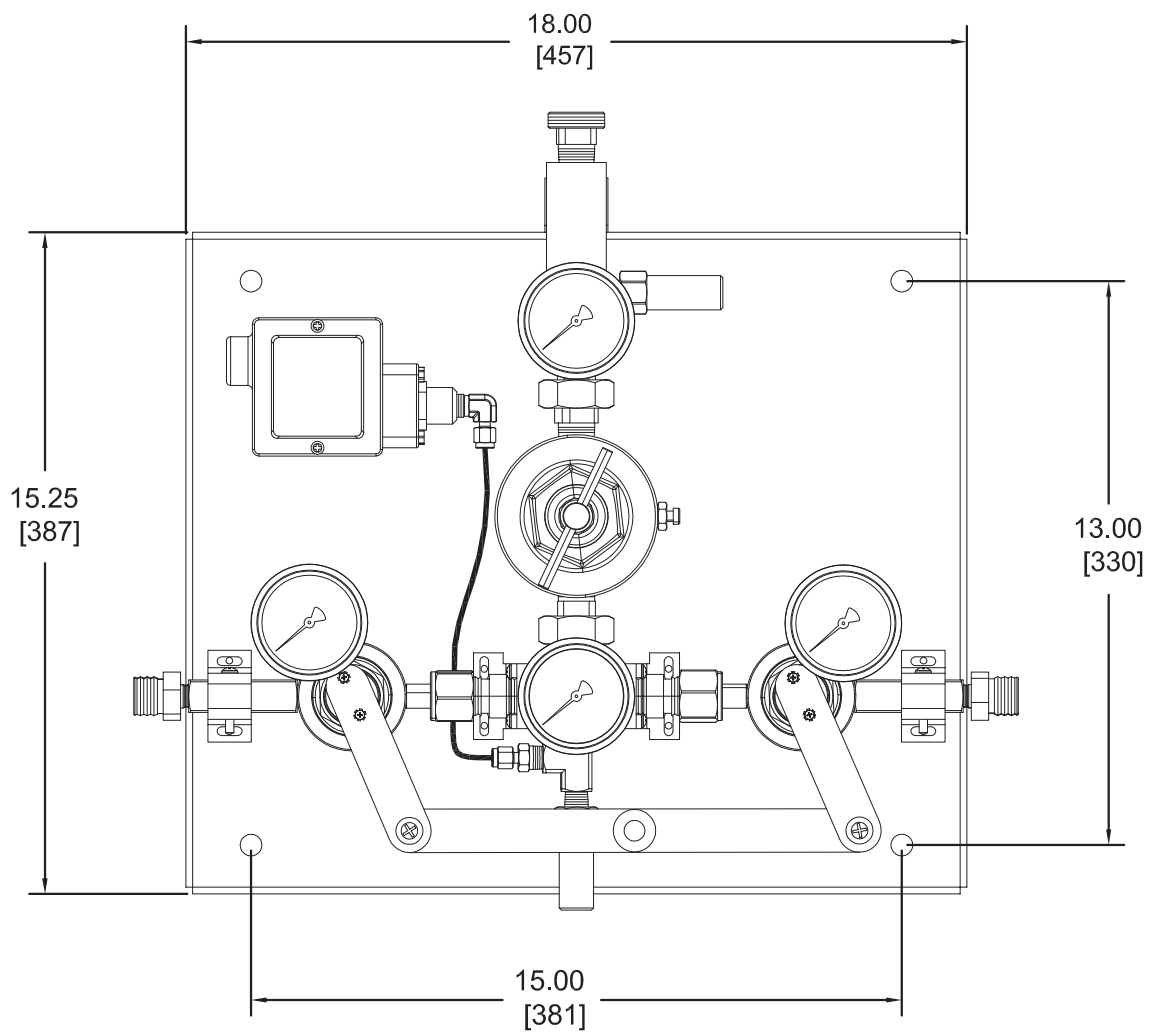

Installation:

Mounting holes are 13" and 15" (33.02 cm and 38.1 cm) apart at the top and bottom of the back plate.

Use appropriate anchors (supplied by others). 3/8" (9.525 mm) diameter anchors are recommended.

Appendix C

Wiring to Alarm/Buzzer

Inch
[mm]

Optional Monitoring Devices

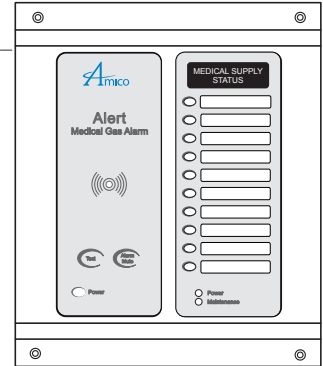
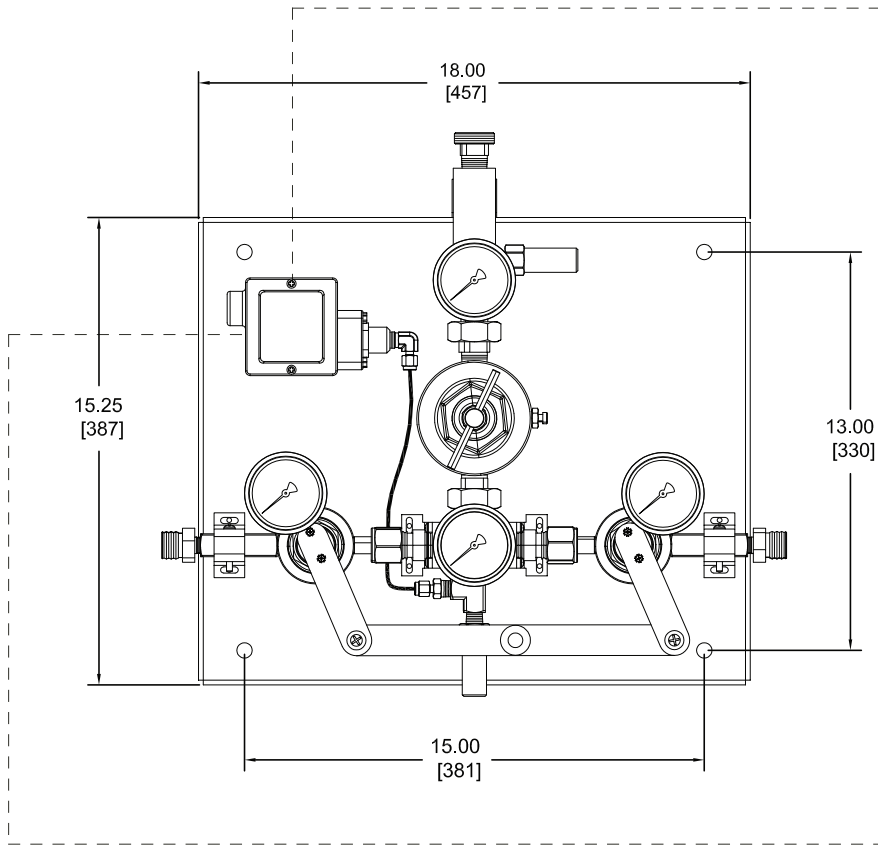

Master Alarm

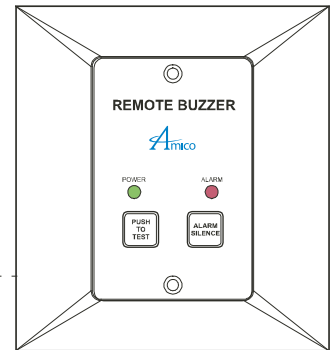

Remote Buzzer



www.amico.com

Amico Corporation | www.amico.com

85 Fulton Way, Richmond Hill
Ontario, L4B 2N4, Canada

Toll Free Tel: 1.877.462.6426
Toll Free Fax: 1.866.440.4986
Tel: 905.764.0800
Fax: 905.764.0862
Email: info@amico.com