

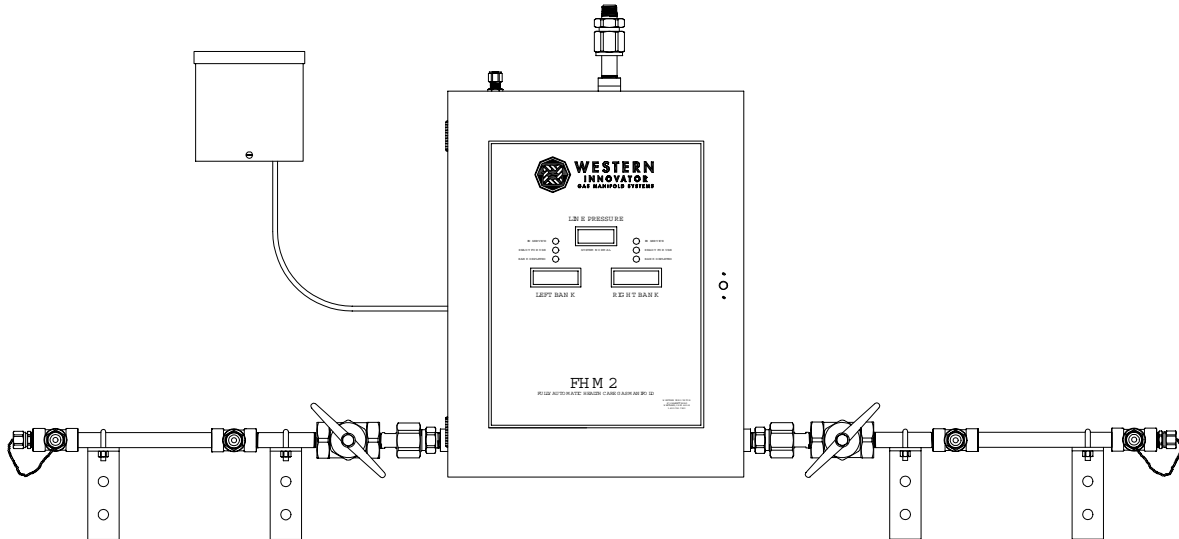

**WESTERN**  
INNOVATOR

**Installation and Operating Instructions For  
FULLY AUTOMATIC CHANGEOVER MANIFOLD  
FHM2, FHM2HL, & FHM2HP SERIES**



## INTRODUCTION

Western manifold systems are cleaned, tested and prepared for the indicated gas service and are built following National Fire Protection Association and Compressed Gas Association guidelines. The manifold consists of a manifold control unit, an internal dual line assembly, and two supply bank headers, one service and one secondary supply to provide an uninterrupted supply of gas for the specific gas application. The manifold control unit is designed and built with features providing automatic changeover from the depleted "Service" supply bank to the "Secondary" supply bank while maintaining a constant delivery pressure. Digital pressure readouts, alarm, signal connections and lights show system status and alert the need to replace depleted cylinders. Features of the automatic system include integral adjustable line regulators, power supply with dry contacts for connecting to a remote alarm, stainless steel braided flexible pigtailed with check valves, rigid wall-mounted headers, and complete mounting hardware.

## CAUTION

### Failure to follow the subsequent instructions can result in personal injury or property damage:

- Never permit oil, grease, or any other combustible material to come in contact with cylinders, manifold, and connections. Oil and grease may react and ignite while in contact with some gases—particularly oxygen and nitrous oxide.
- Cylinder, header, and master valves should always be opened very s-l-o-w-l-y. Heat of recompression may ignite combustible materials.
- Pigtailed should never be kinked, twisted, or bent into a radius smaller than 3 inches. Mistreatment may cause the pigtail to burst.
- Do not apply heat. Some materials may react and ignite while in contact with some gases—particularly oxygen and nitrous oxide.
- Cylinders should always be secured with racks, chains, straps, or stands. Unrestrained cylinders may fall over and damage, or break off the cylinder valve, which may propel the cylinder with great force.
- Oxygen manifolds and cylinders should be grounded. Static discharges and lightning may ignite materials in an oxygen enriched atmosphere, creating a fire or explosion.
- Welding should not be performed near nitrous oxide piping. Excessive heat may cause the gas to dissociate, creating an explosive force.

## WARRANTY

All Western manifolds are warranted against defects in materials and workmanship for the period of one year from date of purchase. See back cover for details of limited warranty.

## TABLE OF CONTENTS

GENERAL INSTRUCTIONS.....	3
COMPONENTS .....	4
CONTROL SECTION INSTALLATION.....	5
HEADER INSTALLATION .....	6
CONNECTING TO THE DELIVERY PIPELINE .....	7
RELIEF VALVE VENT LINE .....	7
ELECTRICAL.....	8
REMOTE ALARM HOOKUP.....	9
INSTALLING PIGTAILS AND ATTACHING CYLINDERS .....	10
START UP AND SYSTEM CHECKING PROCEDURES .....	11
ELECTRICAL POWER UP .....	12
LINE DELIVERY PRESSURE ADJUSTMENT .....	13
MANIFOLD OPERATION .....	14
FHM2HL MODELS FOR USE WITH CARBON DIOXIDE AND NITROUS OXIDE .....	14
CYLINDER REPLACEMENT AND HANDLING .....	15
GENERAL MAINTENANCE.....	15
TROUBLESHOOTING.....	16
MANIFOLD MAINTENANCE .....	18
REPLACEMENT PIGTAILS.....	18
PCB REPLACEMENT PARTS .....	18
PRESSURE GAUGES.....	18
VALVES AND VALVE REPAIR KITS .....	18
PRESSURE SWITCH REPLACEMENT PARTS.....	18
POWER SUPPLY REPLACEMENT PARTS.....	18
PRESSURE TRANSDUCERS.....	18
REGULATOR AND REGULATOR REPAIR KITS.....	19
WARRANTY.....	20

## GENERAL INSTRUCTIONS

Manifolds should be installed in accordance with guidelines stated by the National Fire Protection Association, Compressed Gas Association, Occupation Safety Health Administration, and all applicable local codes. The carbon dioxide and nitrous oxide manifolds should not be placed in a location where the temperature will exceed 120° F (49° C) or fall below 20° F (-7° C). The manifolds for all other gases should not be placed in a location where the temperature will exceed 120° (49° C) or fall below -20° F (-29° C). A manifold placed in an open location should be protected against adverse weather conditions, including direct rain, snow, and heavy moisture. During winter, protect the manifold from ice and snow. In summer, shade the manifold and cylinders from continuous exposure to direct rays, heat of the sun, and rain.

Leave all manifold protective covers in place until their removal is required for installation. This precaution will keep moisture and debris from the piping interior, avoiding operational problems and system contamination.

All safety relief valves shall be piped/vented to the outside. Follow all local and applicable codes for piping systems.

### CAUTION:

- Remove all protective caps from the pigtails and manifold. If left in place, the protective cap may ignite due to heat of recompression in oxygen systems.

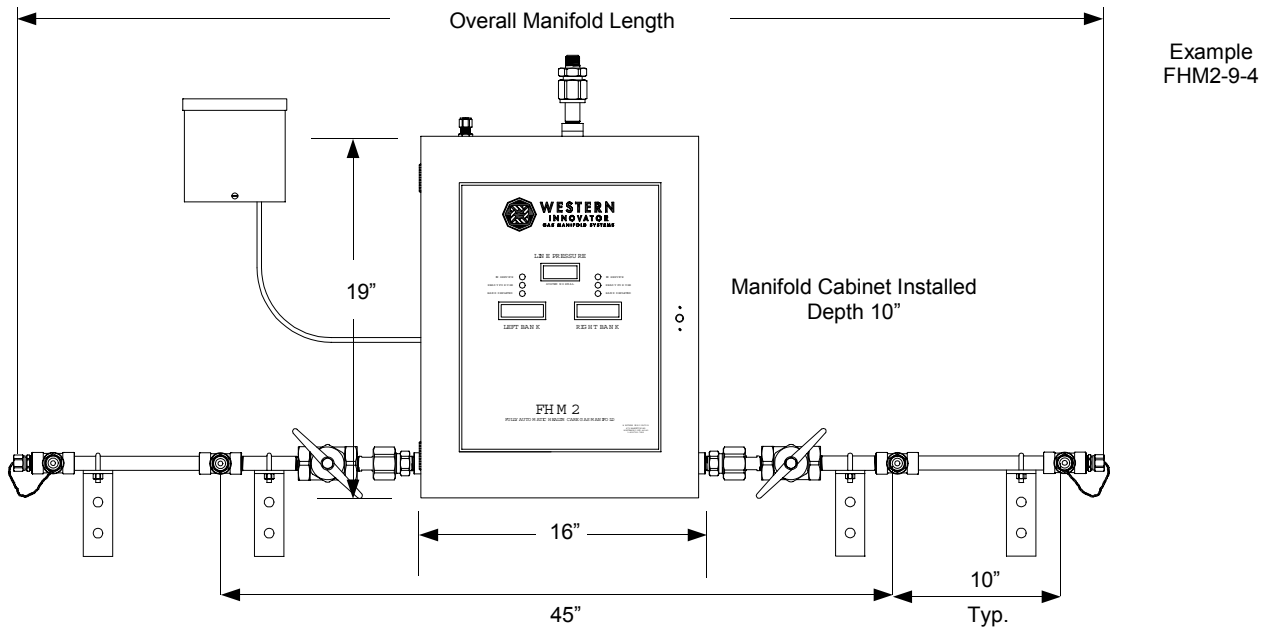
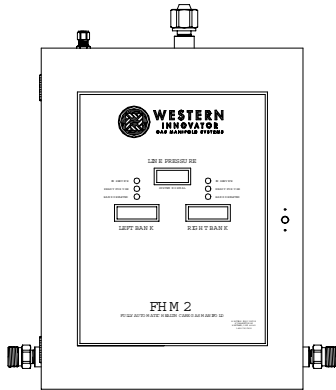

Figure I

Total number of cylinders	4	6	8	10	12
Overall manifold length	5' - 11"	7' - 7"	9' - 3"	10" - 11"	12' - 7"

## FHM2 COMPONENTS

1. Verify that all components below have been received. If any of these items are missing or damaged, please notify your supplier immediately.



**Cabinet Manifold**  
Quantity = 1

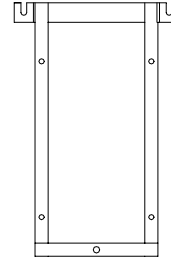

**Bracket**  
Quantity = 1  
(Attached to the back of the manifold)



**Pigtails**  
Quantity = Should match the number of ports on the headers

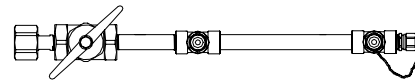

**Headers**  
Quantity = 1 left side  
1 right side

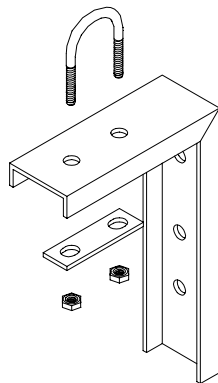

**Brackets**  
Quantity = Varies

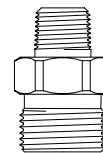

**Outlet Fitting & Union**  
Quantity = 1

## CONTROL SECTION INSTALLATION

1. Determine and mark the vertical center line for installation of the manifold control unit. (Figure 2).
2. Measure from the floor to a point 63.5" in height\* of this vertical line. Using a level, mark a horizontal line at this point extending approximately 10" to the left and 10" to the right of center.

(\*Suggested manifold height. Wall mounting heights may vary from one installation to another depending on available space, cylinder height, etc.)

3. Center the mounting bracket on the vertical line, aligning the top 2 mounting holes with the horizontal line (Figure 3).
4. Holding the bracket as shown in Figure 3 mark the locations for the 5 fasteners.
5. Anchor the mounting bracket to the wall. These fasteners are not provided with the manifold. The type fastener used shall be selected based on the wall type.

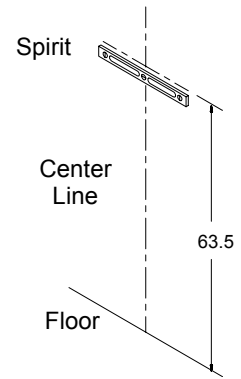

Figure 2

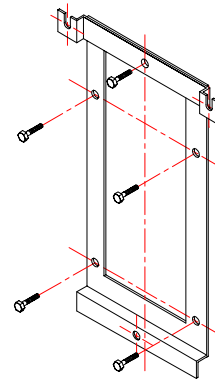

Figure 3

### CAUTION:

- The manifold weighs 65 – 70 lbs. The fasteners chosen shall be sized to hold the weight of the manifold. Undersized fasteners could allow the manifold to fall off the wall which could cause injury.

6. Secure the mounting bracket to the manifold control unit by sliding the round retainers on the back of the cabinet into the slots on the bracket. Place the nut on the bolt which protrudes from the case and tighten lightly. This bolt only stabilizes the bottom of the unit and is not load-bearing (the nut is shipped threaded to the bolt). (Figure 4)

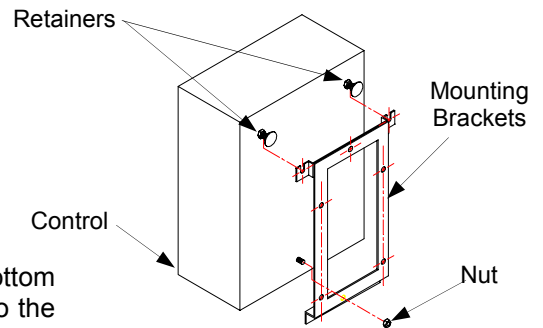

Figure 4

## HEADER INSTALLATION

**NOTE:**

- Half of the brackets will be used on the left side while half will be used on the right side.

1. Attach the left header to the union on the left side of the manifold control unit. Using a level, mark the placement of mounting brackets while keeping the header on a horizontal plane. (Figure 5)

2. Position the brackets so that the top of the bracket is aligned with the bottom of the headers and is centered between the cylinder connections. The brackets should be evenly spaced with the end bracket placed as close to the last cylinder as possible to provide the most support and stability. (Figure 6)

3. Mark the mounting hole and install fasteners suitable for type of wall construction. (Figure 6)

4. Fit the U-bolt over the header piping, through the bracket strap, and tighten the two mounting nuts. (Figure 6)

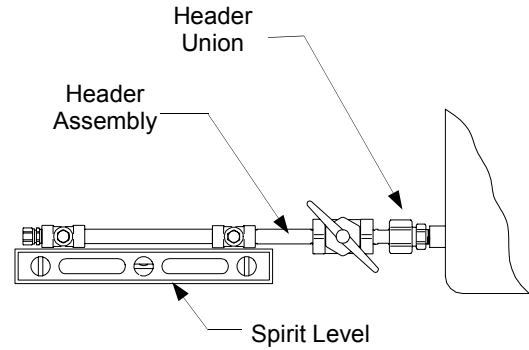

Figure 5

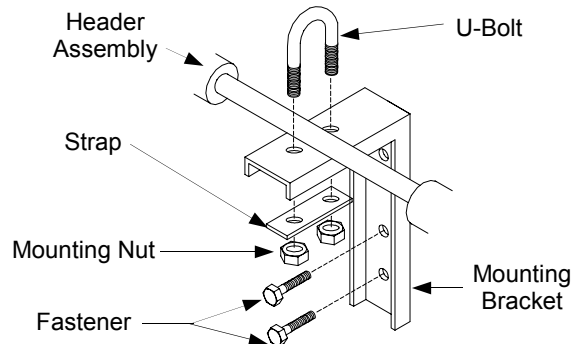
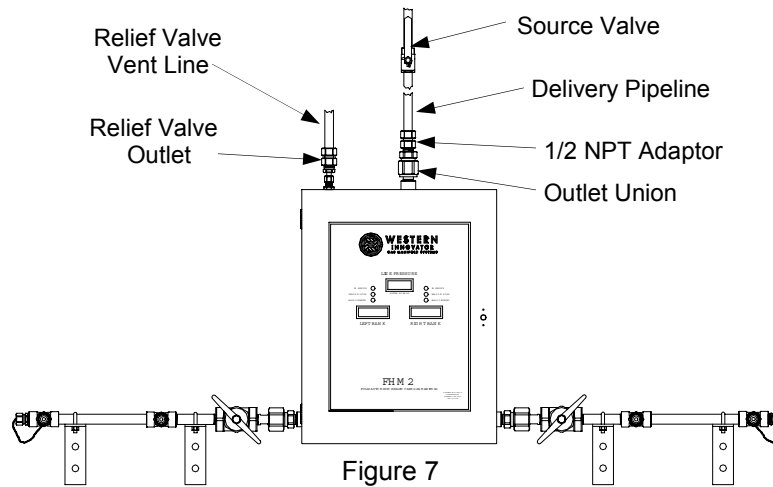

Figure 6

## CONNECTING TO THE DELIVERY PIPELINE

1. An outlet union is supplied with the manifold. The 1/2 NPT end of the outlet fitting shall be attached to the delivery piping using Teflon® tape. (Figure 7)



2. Connect the outlet union to the manifold outlet nut and nipple. (Figure 7)
3. A source valve shall be located near the manifold outlet per current requirements of NFPA 99, section 4-3.1.2.3.

## RELIEF VALVE VENT LINE

### NOTE:

- If the manifold is installed indoors, vent piping must be attached to the manifold relief valve outlet. The vent piping shall be routed outdoors per applicable piping codes.

1. The relief valve outlet union is supplied to connect to the vent piping. The 1/2 NPT relief valve union shall be attached to the vent piping using Teflon® tape. (Figure 7)
2. Connect the relief outlet fitting to the manifold. Thread the compression fitting nut until it is finger tight. Then tighten, using a 11/16 wrench, 1-1/4 turns.

### CAUTION:

- Any brazing performed on the delivery pipeline or relief valve vent line shall be done following the guidelines outlined in the current NFPA 99 Section 4-3 requirements.

## ELECTRICAL

### CAUTION:

- Turn off all power while connecting and wiring the power supply.

1. A 24 VAC power supply transformer is furnished with the manifold control unit. Mount the box onto the wall, to the left of the manifold, with the top edge approximately aligned with top of the control unit. The attached control cable terminates into a 7 prong plug matching a receptacle on the left side of the control unit, (Figure 8).
2. After mounting the power supply box to the wall, plug the cable into the control unit receptacle.

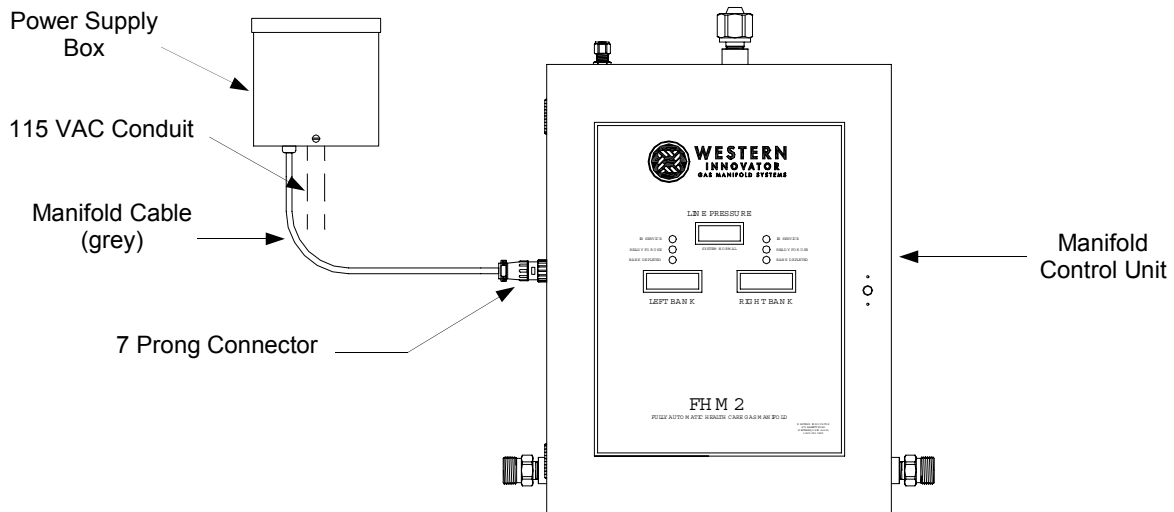

Figure 8

3. The center hole on the underside of the power supply box provides access for conduit and connection of 115 VAC power. Connect the 115 VAC black and white leads to the power supply as shown. (Figure 9)

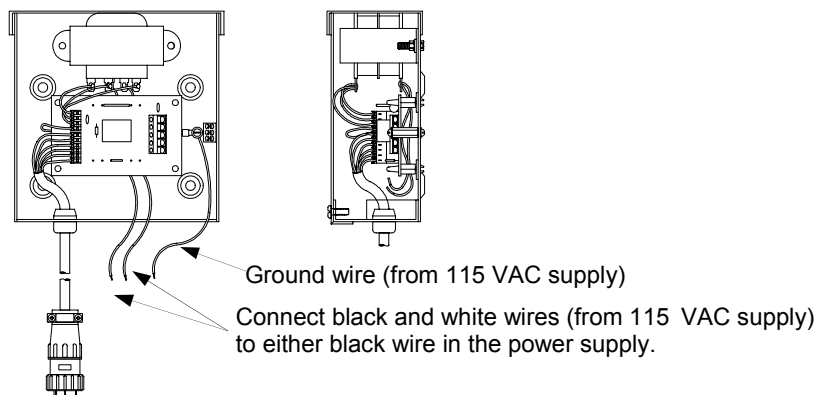

Figure 9

4. Connect the ground wire to the ground terminal as shown in figure 9.
5. After completing the 115 VAC connections, the power supply should be completely installed and 115 VAC power can be applied.
6. Manifolds with heater have a 3 prong cord that should be plugged into a standard 115 VAC that can provide 4 AMPS.



## REMOTE ALARM HOOKUP

A five terminal remote alarm terminal strip is on the right side of the circuit board in the power supply box for remote alarm interfacing. The top three terminals on the strip (N/C, N/O, and C) provide dry contacts for remote alarm hookup. Wiring diagrams for remote audio/visual alarms are included with the alarms. Listed below are four different remote alarm configurations. Terminals identified as N/O and N/C have been marked in the unactuated state.

**In some instances the power supply for the remote alarm is normally part of the electrical contract on proposed constructions and should exist in any furnished facility. The following procedure should be followed:**

1. Two alarm signal wire requiring dry contacts should run to the manifold location.
2. Connect one signal wire to the common (C) terminal and the other signal wire to the normally open (N/O) terminal on the terminal strip on the right side in the power supply box. (Figure 10)

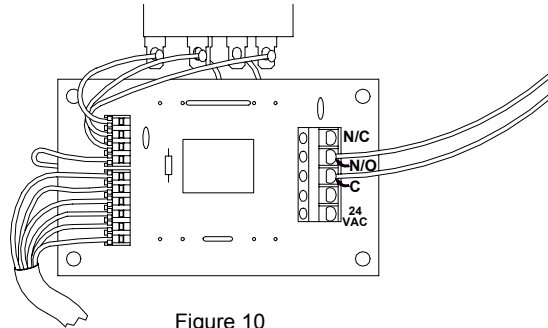

Figure 10

**If the remote alarm is designed for 24 VAC operation, then connect the alarm as follows: (Also see WESTERN'S ALARM section on next page)**

1. Connect the ground wire from the alarm to one 24 VAC terminal on the right side of the circuit board in the power supply box. (Figure 11)
2. A jumper wire is connected between the other 24 VAC terminal and the common (C) terminal.
3. Connect the "reserve in use" signal wire to the (N/C) terminal.
4. If a "system normal" signal is also employed, connect that signal wire to the normally open (N/O) terminal.

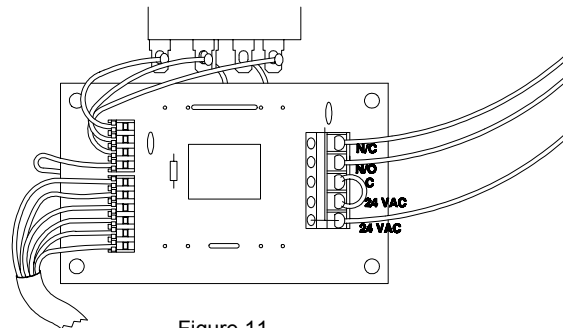

Figure 11

**If the remote alarm is designed for voltages other than 24 VAC, then connect the alarm as follows:**

1. Connect the ground wire from the alarm to the negative (-) connection at the power source. (Figure 12)
2. There should be NO connections to the 24 VAC terminals on the right side of the circuit board.
3. Connect the positive (+) connection from the power source to the common (C) terminal on the circuit board.
4. Connect the "reserve in use" signal wire to the normally closed (N/C) terminal.
5. If a "system normal" signal is also employed, connect that signal wire to the normally open (N/O) terminal.

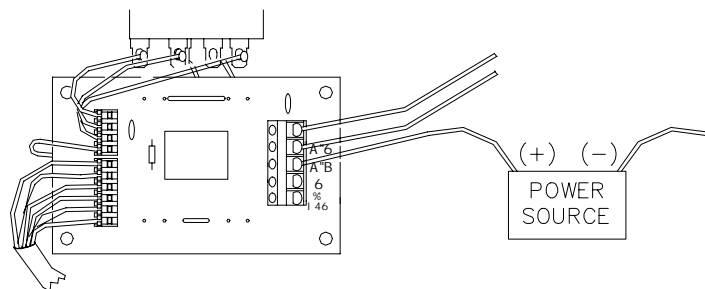

Figure 12

## WESTERN'S ALARM

1. Connect one 24 VAC lead from the alarm to one 24 VAC terminal on the right side of the circuit board in the power supply box. (Figure 13)
2. Connect the other 24 VAC lead from the alarm to the other 24 VAC terminal.
3. A jumper wire is connected between one 24 VAC terminal and the common (C) terminal.
4. Connect the alarm signal wire to the normally open (N/O) terminal.

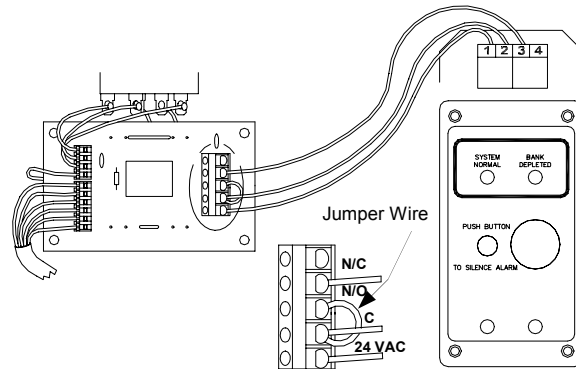

Figure 13

## INSTALLING PIGTAILS AND ATTACHING CYLINDERS

1. Remove plastic protective covers from all pigtails.
2. Establish flow direction of check valve in pigtails.
3. Connect pigtails to header check valve outlet bushing with direction of check valve flow from cylinder to manifold end of pigtail (the check valve end of the pigtail should be connected to the cylinder). (Figure 14)
4. Check master valves to verify that they are open (turn counter-clockwise to open).
5. Remove protective cylinder caps from full replacement cylinders. With the valve outlet pointed away from you or anyone else, slowly open each cylinder valve slightly to blow out any dirt or contaminants which may have become lodged into the cylinder valve.
6. Place and secure full cylinders into position using chains, belts, straps, or cylinder stands.
7. Connect pigtails to cylinder valves and tighten securely.
8. S-L-O-W-L-Y turn each cylinder valve until each cylinder is fully open.

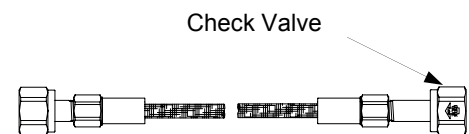

Figure 14

### CAUTION:

- Pigtails should never be kinked, twisted, or bent in a radius smaller than 3 inches. Mistreatment may cause pigtail to burst (refer to attached caution tags on each pigtail).

9. Check all cylinder and pigtail connections for leaks using Western leak detector LT-100 or an oxygen safe equivalent solution.
10. Observe the following conditions:
  - The line pressure will be indicated on the front of the cabinet.
  - The pressure reading on each bank being pressurized will display cylinder pressure.
  - The green "In Service" and yellow "Ready for Use" lights are illuminated when both banks are full.

## START UP AND CHECKING PROCEDURE

1. S-L-O-W-L-Y open one cylinder valve on the right bank (turn counter-clockwise to open). The right bank pressure gauge should show the full pressure of the right bank of cylinders. The red “Depleted Bank” light on the right bank will be extinguished.
2. S-L-O-W-L-Y open one cylinder valve on the left bank. The left bank pressure gauge will show the full pressure of the left bank of cylinders. The yellow “Ready for Use” light comes on, extinguishing the red “Depleted Bank” light, on the left side.
3. Create a slight flow of gas by opening the bleeder valve inside the manifold. Close the right cylinder valve to simulate a depleting right bank. (see Figure 15) Observe the following:
  - The right bank pressure slowly falls and the manifold control automatically switches over to the left bank.
  - Delivery pressure remains constant.
  - Green “In Service” light is extinguished.
  - Red “Replace Depleted Bank” light on the right bank illuminates.
  - Any remote alarms should be activated at this time.
  - The left bank green “In Service” light comes on, extinguishing the yellow “Ready for Use” light.
4. S-L-O-W-L-Y reopen the right cylinder valve. Observe the following:
  - Right bank pressure returns to full pressure.
  - Yellow “Ready for Use” light illuminates.
  - Red “Depleted Bank” light is extinguished.
  - Any remote alarms should be canceled.
5. Repeat procedures 3 & 4 simulating an empty left bank.

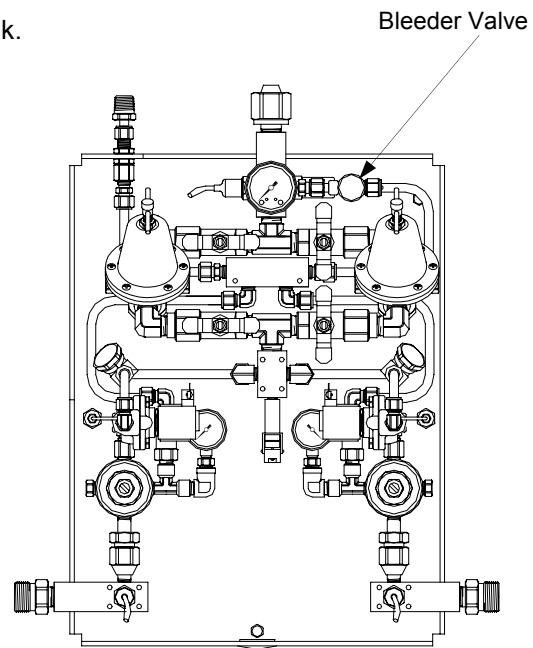

Figure 15

## ELECTRICAL POWER-UP

- When power is applied to the manifold, the displays will first cycle through a power up sequence before displaying the pressures. This process takes approximately 16 seconds.
  - All of the Status indication lights will be lit.
  - The lights will go out sequentially.
  - The state of the DIP switches will be shown on the digits of the right bank display and the right most digit to the left of the left bank display as a series of "1"s and "0"s.
  - The display will show all "8".
  - Each digit of the display will be lit individually.
- The displays and status indicators will then be allowed to operate normally.

## UNITS OF MEASURE

- The FHM2 manifold can be configured to display pressure in PSI, KPa or BAR. The manifold is shipped with PSI as the default unit of measure. To switch the units, proceed to step 2. If PSI units are desired, no changes are necessary and step 2 may be skipped.
- To change the units, perform the following steps:
  - Remove power to the manifold (switches are only read during power-up).
  - Open the door of the manifold.
  - Locate the DIP switches at the bottom edge of the PC Board on the door.

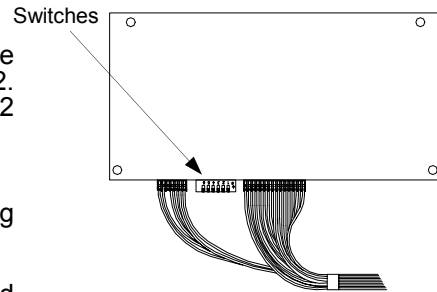

- For PSI set the switches as shown:

Model FHM2

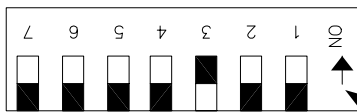

Model FHM2HL

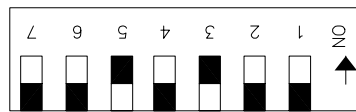

Model FHM2HP:

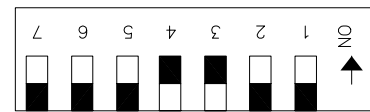

Switch Position

- For KPa set the switches as shown:

Model FHM2

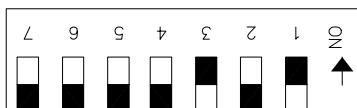

Model FHM2HL



Model FHM2HP:

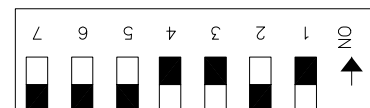

- For BAR set the switches as shown:

Model FHM2

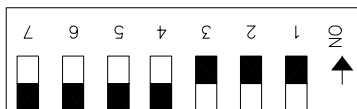

Model FHM2HL

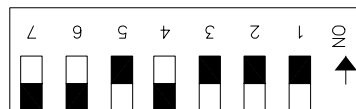

Model FHM2HP:

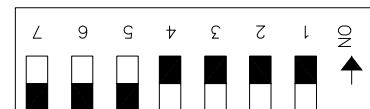

- Close the cover and reconnect power to the manifold.
- Verify that during power-up the status of the switches are displayed on the digits of the right bank display and the right most digit of the left bank display as a series of "1"s and "0"s as follows:

## DIP SWITCH/DISPLAY OPTION

- For PSI:  
Model FHM2

<u>Left Display</u>	<u>Right Display</u>
<input type="checkbox"/> <input type="checkbox"/> <input type="checkbox"/> 1 1	0 1 1 1 1

Model FHM2HL

<u>Left Display</u>	<u>Right Display</u>
<input type="checkbox"/> <input type="checkbox"/> <input type="checkbox"/> 1 1	0 1 0 1 1

Model FHM2HP:

<u>Left Display</u>	<u>Right Display</u>
<input type="checkbox"/> <input type="checkbox"/> <input type="checkbox"/> 1 1	0 0 1 1 1

- For KPA;  
Model FHM2

<u>Left Display</u>	<u>Right Display</u>
<input type="checkbox"/> <input type="checkbox"/> <input type="checkbox"/> 0 1	0 1 1 1 1

Model FHM2HL

<u>Left Display</u>	<u>Right Display</u>
<input type="checkbox"/> <input type="checkbox"/> <input type="checkbox"/> 0 1	0 1 0 1 1

Model FHM2HP:

<u>Left Display</u>	<u>Right Display</u>
<input type="checkbox"/> <input type="checkbox"/> <input type="checkbox"/> 0 1	0 0 1 1 1

- For BAR:  
Model FHM2

<u>Left Display</u>	<u>Right Display</u>
<input type="checkbox"/> <input type="checkbox"/> <input type="checkbox"/> 0 0	0 1 1 1 1

Model FHM2HL

<u>Left Display</u>	<u>Right Display</u>
<input type="checkbox"/> <input type="checkbox"/> <input type="checkbox"/> 0 0	0 1 0 1 1

Model FHM2HP:

<u>Left Display</u>	<u>Right Display</u>
<input type="checkbox"/> <input type="checkbox"/> <input type="checkbox"/> 0 0	0 0 1 1 1

## LINE DELIVERY PRESSURE ADJUSTMENT

The delivery pressure has been factory set. If adjustment is required, carefully proceed according to the following instructions:

1. Leave the manifold in full operational status.
2. Create a flow condition in the delivery pipeline system.
3. Locate the left or right line pressure regulator that is feeding the system (open ball valves).
4. Adjustment: Turn clockwise to “increase” pressure, turn counter-clockwise to “decrease” pressure.  
\* Refer to either the line pressure gauge on outlet block or the LED display on the front of the manifold door.
5. Close door and latch.

## MANIFOLD OPERATION

The manifold control unit includes the following components and features: green “In Service”, yellow “Ready for Use”, and red “Bank Depleted” indicator lights”, digital cylinder pressure readouts, digital line pressure readout and gauge, intermediate pressure gauge, internal dual line regulator assembly, intermediate relief valves, line relief valve, and fully automatic bank switching. Supply bank consist of a header with 24” and/or 36” stainless steel flexible pigtails with check valves, individual header check valve outlet bushings, master shut off valves, and union connections for attachment to the control unit.

After initial powerup and with both banks empty, both read and green LED’s will be illuminated. The bank that is pressurized first will be considered in service.

The cylinder bank that supplies the piping system is known as the “Service” supply (as indicated by the green “In Service” light), while the cylinders on stand-by are referred to as the “Secondary” supply (as indicated by the yellow “ready for use” light. On the service bank, the gas flows into the manifold control unit inlet to the bank pressure transducer, then into the primary regulator before heading into an intermediate gauge. The gas then flows through a solenoid valve and into the dual line assembly. The valves leading to one line regulator should be closed. This regulator is to be used as an emergency back up. The gas flows through the open valve leading to the other line regulator. Delivery pressure is controlled by the line regulator and is adjustable (See Delivery Line Adjustment– page 13). The gas exits the line regulator and proceeds past the line pressure transducer and pressure gauge and into the delivery piping.

The gas on the secondary bank flows into the manifold cabinet to the bank pressure transducer. The gas then flows through the primary regulator and into an intermediate gauge. The gas then enters a solenoid. Since this is the secondary bank, the solenoid is closed, preventing the secondary bank from flowing.

Changeover from the “Service” to “Secondary” side is accomplished when the service pressure drops below a predetermined point (this changeover pressure is determined by the manifold PCB). The PCB then signals the secondary bank solenoid to open, allowing it to start to flow without any interruption in line delivery pressure.

There are two definite indicators as to which bank should be changed; (1) red “Bank Depleted” light and (2) cylinder bank pressure readout.

After replacing empty cylinders, open the cylinder valves. The PCB will read this pressure and automatically place the fresh bank of cylinders into reserve, making it the secondary bank. The yellow light will come on indicating the new bank is ready for use, and the red “Bank Depleted” light will be extinguished. Replacing the empty cylinders is all that is required to reset the manifold.

To insure proper operation, observe the following guidelines:

1. Carefully follow all instructions.
2. Establish proper flow direction of check valves.
3. Be sure cylinder valves are fully opened.
4. Replace depleted cylinders as soon as practical after the red “Bank Depleted” light comes on.

## FHM2HL – MODELS FOR USE WITH CARBON DIOXIDE AND NITROUS OXIDE GAS.

Nitrous Oxide and Carbon Dioxide systems include a 500 SCFH capacity heater. The thermostatically controlled heater warms the gas before entering the regulator, preventing regulator and system “freeze-up”. The control is supplied with a 7 foot cord and plug for 115 VAC power and draws 4 AMPS.

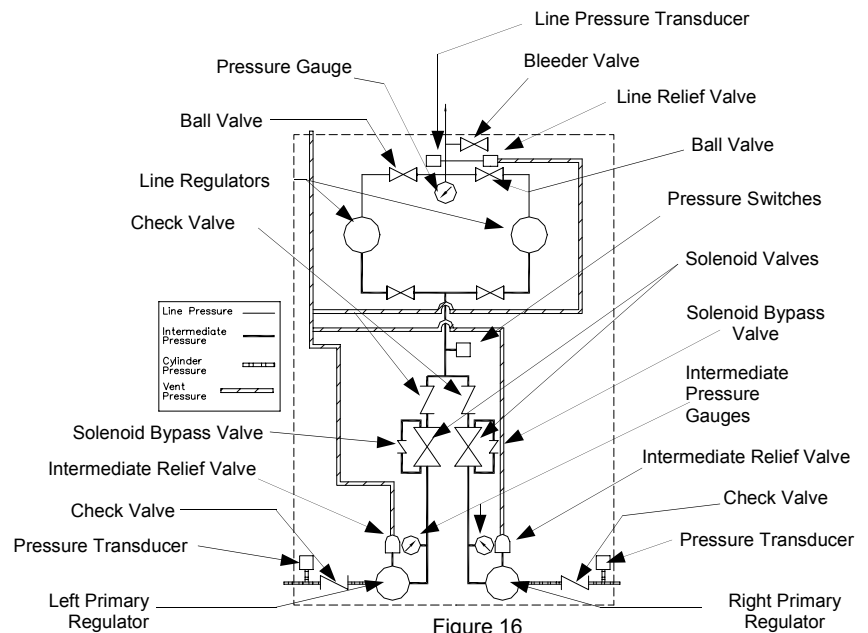

## CYLINDER REPLACEMENT & HANDLING

1. Shut off all cylinder valves and header valves as well as the master valve on depleted cylinder bank.
2. S-L-O-W-L-Y loosen and remove the pigtail connection from the depleted cylinders.
3. Remove depleted cylinders and replace protective caps.
4. Remove protective cylinder caps from full replacement cylinders. With the valve outlet pointed away from you or anyone else, slowly open each cylinder valve slightly to blow out any dirt or contaminants which may have become lodged into the cylinder valve.
5. Place and secure full cylinders into position using chains, belts, straps, or cylinder stands.
6. Connect pigtails to cylinder valves and tighten securely.

### CAUTION:

- Pigtails should never be kinked, twisted, or bent into a radius smaller than 3 inches. Mistreatment may cause the pigtail to burst. (Refer to attached caution tag on each pigtail)

7. S-L-O-W-L-Y open master valves.
8. S-L-O-W-L-Y turn each cylinder valve until each cylinder is fully open (turn counter-clockwise to open).
9. Check all cylinder/pigtail connections for leaks using Western Leak Detector, LT-100 or an equivalent oxygen safe solution. Repair or replace any connections that show signs of bubbles which indicates leakage.
10. Observe the following conditions:
  - The pressure reading on the bank being pressurized will display cylinder pressure.
  - The red "Bank Depleted" light goes out and the yellow "Ready for Use" light come on.
  - No interruption in gas service or line pressure.

## GENERAL MAINTENANCE

1. Main Section
  - a) Daily – record line pressure
  - b) Monthly
    - 1) Check regulators, valves and compression fittings for external leakage.
    - 2) Check valves for closure ability.
  - c) Annually
    - 1) Check relief valve pressures.
    - 2) Replace regulator seats.
2. Manifold Header
  - a) Daily – observe nitrous oxide and carbon dioxide systems for cylinder frosting or surface condensation. Should excessive condensation or frosting occur, it may be necessary to increase manifold capacity.
  - b) Monthly
    - 1) Inspect valves for proper closure.
    - 2) Check cylinder pigtails for cleanliness, flexibility, wear, leakage, and thread damage. Replace damaged pigtails immediately.
    - 3) Inspect pigtail check valves for closure ability.
  - c) Every Four Years
    - 1) Replace all pigtails.

<b>SYMPTOM</b>	<b>PROBABLE CAUSE</b>	<b>REMEDY OR CHECK</b>
<b>PRIMARY REGULATOR</b>		
Venting at relief valve.	Over pressure due to creeping or faulty regulation of primary regulator.	Replace regulator seat and nozzle components.
Gas leakage around regulator body and bonnet	Loose bonnet.	Tighten bonnet.
	Diaphragm leak.	Replace diaphragm.
<b>LINE PRESSURE REGULATOR</b>		
Gas leakage around regulator body/bonnet.	Loose bonnet.	Tighten bonnet.
Pipeline not at desired pressure.	Line regulator not set correctly.	Set delivery pressure per specifications.
Required gas flow not available.	Line regulator not set correctly.	Set delivery pressure per specifications.
	Flow capacity too high.	Reduce flow capacity.
<b>SOLENOID VALVES</b>		
Gas leakage through a closed solenoid.	Solenoid faulty.	Replace solenoid.
	Power not reaching the solenoid.	Check all wiring connections.
<b>Electrical System</b>		
No indicator lights or displays on front panel come on when power is hooked up.	Power Input.	Check electrical power supply.
	Internal wiring disconnected.	Check all wiring connections.
	Manifold controller PCB defective.	Replace manifold controller PCB.
Red indicator light(s) on but both banks are full. (green light on one bank is on)	Master valve, header valves, or cylinder valves on bank are closed.	Slowly open valves.
	Bank pressure below minimum inlet pressure requirements.	Replace cylinders.



SYMPTOM	PROBABLE CAUSE	REMEDY OR CHECK
<b>Electrical System (continued)</b>		
Red indicator light does not come on when one bank is empty and changeover occurs.	LED defective	Replace manifold controller PCB.
Green indicator light does not come on even though both banks are full.	Manifold controller PCB defective.	Replace manifold controller PCB.
	Pressure switch wiring incorrect or disconnected.	Check pressure switch wiring.
	Pressure switch set at too high a pressure.	Adjust pressure switch.
Display reads "0" even when pressure is present.	Pressure transducer wiring disconnected or faulty.	Check pressure transducer and controller board connections.
	Pressure transducer faulty.	Replace transducer.
Display incorrect.	Dip switches set incorrectly.	Check setting of the Dip switches.
	Pressure transducer faulty.	Replace transducer.
One of the green indicators is on and both red indicators are blinking.	Non-volatile memory failure.	Replace manifold controller PCB.
No display and the green indicator is flashing.	Input out of range during calibration routine.	Adjust the line and primary regulators prior to calibration.
Both Green LEDs are on and both Red LEDs are on. (both banks pressurized)	Pressure switch faulty.	Replace the pressure switch.
	Pressure switch wiring disconnected.	Check wiring connections.
	Wiring to pressure switch not correct.	Check internal leads to the pressure switch.
	Pressure switch set to open above the primary regulator setting.	Adjust the switch/regulator to the correct setting.
Display indicating incorrect units.	Dip Switches must be set with power off.	Remove power, set DIP switches turn power back on.

## MANIFOLD MAINTENANCE & REPAIR PARTS

### NOTE:

- Western manifold systems are designed and tested for optimal performance and adherence to safety specifications. We recommend the use of Western replacement components to maintain the standards of performance and the safety of the product.

## REPLACEMENT PIGTAILS

24" Stainless Steel Flexible Braid with Check Valves

PF-280CV-24 ..... CGA 280 for medical gas mixtures  
PF-320CV-24 ..... CGA 320 for Carbon Dioxide (CO<sub>2</sub>) Service  
PF-326CV-24 ..... CGA 326 for Nitrous Oxide (N<sub>2</sub>O) Service  
PF-63CV-24 ..... CGA 540 for Oxygen (O<sub>2</sub>) Service  
PF-92CV-24 ..... CGA 580 for Nitrogen (N<sub>2</sub>) Service  
PF-346CV-24 ..... CGA 346 for Compressed Air

24" Synthetic Fiber Braid Hose with Check Valve

PFS-92CV-24 ..... CGA 580 for Helium (He) Service

## PCB REPLACEMENT PARTS

WME-8-98 ..... Manifold Controller PCB

## PRESSURE GAUGES – 2" Diameter, 1/4" NPT Back Port

WMG-3-3 ..... 100 psi Line gauge FHM2, FHM2HL  
WMG-3-4 ..... 400 psi Line gauge FHM2HP  
WMG-3-4 ..... 400 psi Intermediate gauge

## VALVES AND VALVE REPAIR KITS

WMS-1-53 ..... CGA 540 Check Valve Bushing	WMS-1-59 ..... CGA 326 Check Valve Bushing
WMV-2-16 ..... Master Valve	WMS-1-62 ..... CGA 346 Check Valve Bushing
RK-1085 ..... Repair kit for WMV-2-16	WMS-1-54 ..... CGA 580 Check Valve Bushing
RK-1041 ..... Repair kit for low pressure check valves	WMS-1-65 ..... CGA 320 Check Valve Bushing
WMS-1-64 ..... CGA 280 Check Valve Bushing	

## PRESSURE SWITCHES

WME-4-4 ..... Pressure Switch (all gases except Oxygen)  
WME-4-4C ..... Pressure Switch (Oxygen)

## POWER SUPPLY REPLACEMENT PARTS

WMS-13-23 ..... Power Supply Assembly (transformer, PCB, case, and cable)  
WME-8-85 ..... Power Supply PCB (includes dry contacts for remote alarms)

## PRESSURE TRANSDUCERS

WME-9-1A ..... 2500 PSIG inlet transducer FHM2, FHM2HL, FHM2HP  
WME-9-2A ..... 250 PSIG line transducer FHM2HP  
WME-9-3A ..... 100 PSIG line transducer FHM2, FHM2HL

## MANIFOLD MAINTENANCE & REPAIR PARTS

### FHM2 SERIES REGULATORS AND REGULATOR REPAIR KITS

#### FHM2 Series Primary Regulators

- WMS-14-8 ..... Left Primary Regulator for FHM2 (Oxygen & Medical Mixtures)
- WMS-14-9 ..... Right Primary Regulator for FHM2 (Oxygen & Medical Mixtures)
- WMS-14-26 ..... Left Primary Regulator for FHM2 (Air, He, N<sub>2</sub>)
- WMS-14-27 ..... Right Primary Regulator for FHM2 (Air, He, N<sub>2</sub>)
- WMS-14-28 ..... Left Primary Regulator for FHM2HL (CO<sub>2</sub> & N<sub>2</sub>O )
- WMS-14-29 ..... Right Primary Regulator for FHM2HL (CO<sub>2</sub> & N<sub>2</sub>O)
- WMS-14-30 ..... Left Primary Regulator for FHM2HP (Air, He, N<sub>2</sub>)
- WMS-14-31 ..... Right Primary Regulator for FHM2HP (Air, He, N<sub>2</sub>)
- RK-1037 ..... Repair Kit for WMS-14-26, WMS-14-27, WMS-14-28, WMS-14-29, WMS-14-30 & WMS-14-31  
(Primary Regulator)
- RK-1038 ..... Repair Kit for WMS-14-8 and WMS-14-9 (Primary Regulator)

#### FHM2 Series Line Regulators

- WLR-14-50L ..... Line Regulator for FHM2 & FHM2HL (Air, He, CO<sub>2</sub>, N<sub>2</sub>O, O<sub>2</sub>, N<sub>2</sub>)
- WLR-14-50R ..... Right Line Regulator for FHM2 & FHM2HL (Air, He, CO<sub>2</sub>, N<sub>2</sub>O, O<sub>2</sub>, N<sub>2</sub>)
- WLR-14-200L ..... Left Line Regulator for FHM2HP (Air, He, N<sub>2</sub>)
- WLR-14-200R ..... Right Line Regulator for FHM2HP (Air, He, N<sub>2</sub>)
- RK-1160 ..... Repair Kit for WLR-14-50R (L) and WLR-14-200R (L)

#### FHM2 Series Solenoid Valves

- 8423 ..... Solenoid valve for FHM2 & FHM2HP (Air, He, O<sub>2</sub>, N<sub>2</sub>)
- 8422 ..... Solenoid valve for FHM2HL (CO<sub>2</sub>, N<sub>2</sub>O, )

#### FHM2 Series Printed Circuit Boards-Calibrated

- WME-8-98A ..... PCB-Calibrated for FHM2 (Air, He, O<sub>2</sub>, N<sub>2</sub>)
- WME-8-98B ..... PCB-Calibrated for FHM2HL (CO<sub>2</sub>, N<sub>2</sub>O, )
- WME-8-98C ..... PCB-Calibrated for FHM2HP (Air, He, O<sub>2</sub>, N<sub>2</sub>)

## LIMITED WARRANTY

WARRANTY: The Seller expressly warrants that the products manufactured by it will be free from defects in material, workmanship and title at the date of shipment. This Warranty is exclusive and is IN LIEU OF ALL IMPLIED OR STATUTORY WARRANTIES (INCLUDING WITHOUT LIMITATION, WARRANTIES AS TO MERCHANTABILITY OR FITNESS FOR A PARTICULAR PURPOSE, OR ARISING FROM COURSE OF DEALING OF USAGE OR TRADE) or any other express or implied warranties or representations. All claims under this warranty must be made in writing and delivered to the Seller prior to the expiration of 1 year from the date of shipment from the factory, or be barred. Upon receipt of a timely claim, the Seller shall inspect the item or items claimed to be defective, and Seller shall at its option, modify, repair, or replace free of charge, any item or items which the Seller determines to have been defective at the time of shipment from the factory, excluding normal wear and tear. Inspection may be performed at the Seller's plant and in such event, freight for returning items to the plant shall be paid by Buyer. Seller shall have no responsibility if such item has been improperly stored, installed, operated, maintained, modified and/or repaired by an organization other than the Seller. Adjustments for products not manufactured by Seller shall be made to the extent of any warranty of the manufacturer or supplied thereof. The foregoing shall be the Seller's sole and exclusive liability and Buyer's sole and exclusive remedy for any breach of warranty or for any other claim based on any defect, or non-performance of, the products whether based on breach of contract or in tort, including negligence or strict liability.



**WESTERN**  
INNOVATOR

875 Bassett Road  
Westlake, Ohio 44145-1142  
(440) 871-2160  
FAX: (440) 835-8283